

A4 316 Equivalent Corrosion Resistance

0-1km

Hilti Corrosion handbook / DFTM

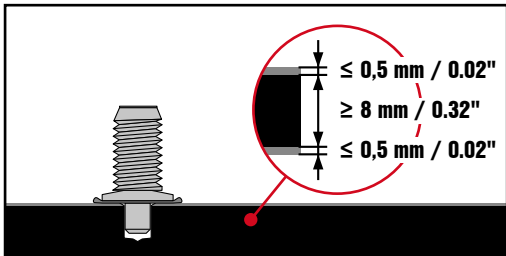

| | | | |
|----------------------|------------|--------------------|-------------------------|
| | | | |
| X-BT-GR M8/7 SN 8 | DX 351-BTG | TX-BT 4.7/7 110 | ¼" 20 Nm/ 14.8 ft lb |

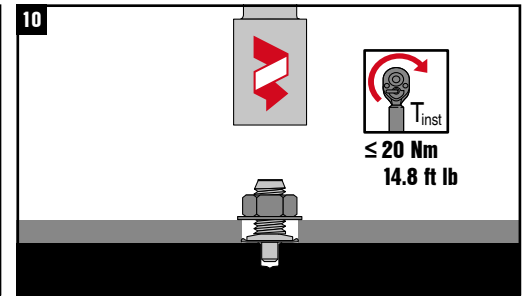
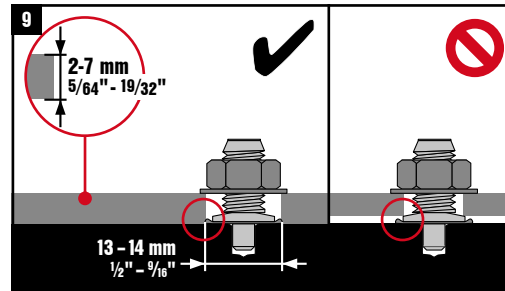
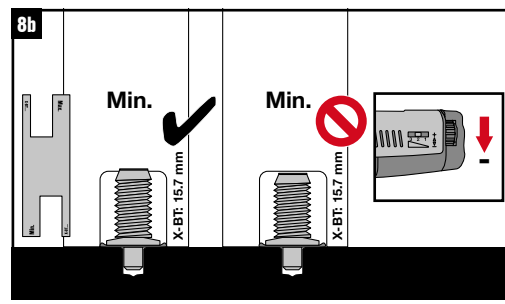
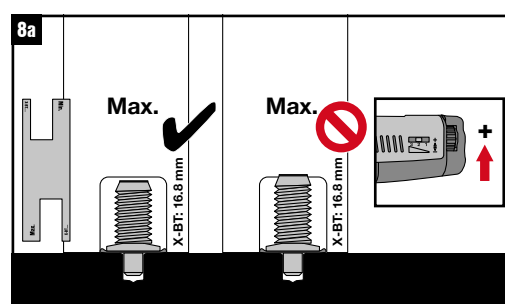
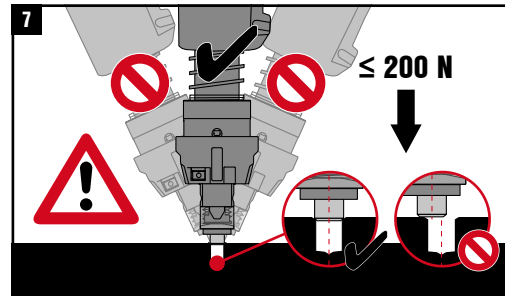
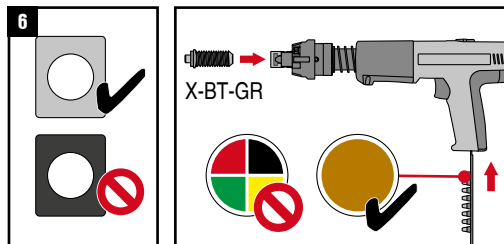
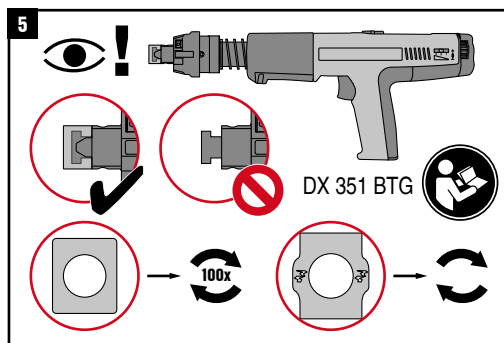
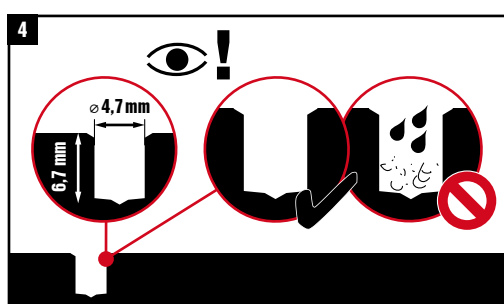
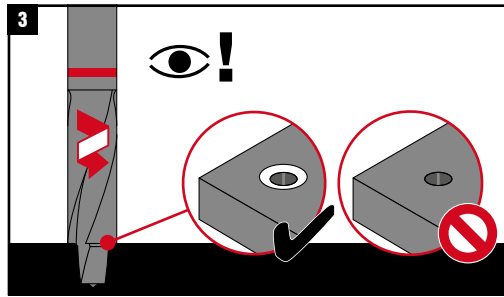
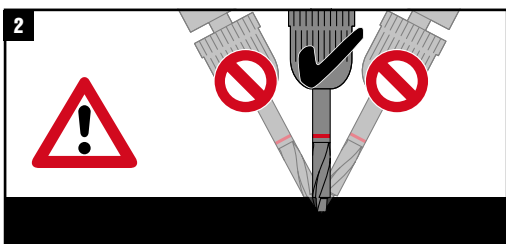
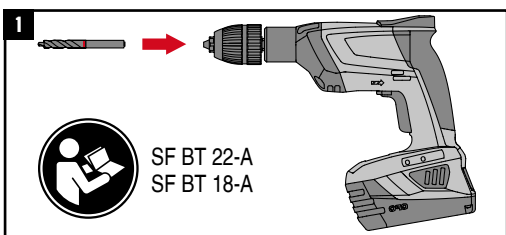

A4 316 Equivalent Corrosion Resistance

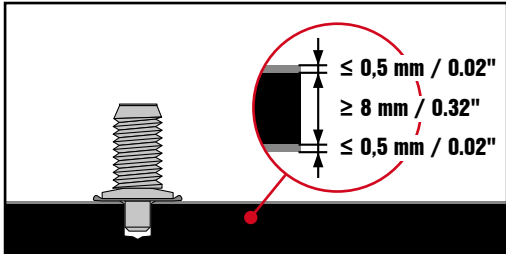

| | | | |
|----------------------|----------|--------------------|-------------------------|
| | | | |
| X-BT-GR M8/7 SN 8 | BX 3-BTG | TX-BT 4.7/7 110 | ¼" 20 Nm/ 14.8 ft lb |

